

MODELO	QDCA	STRING BOX
PHB25K-DT	68 (380/220V)	STB06-1000V/03

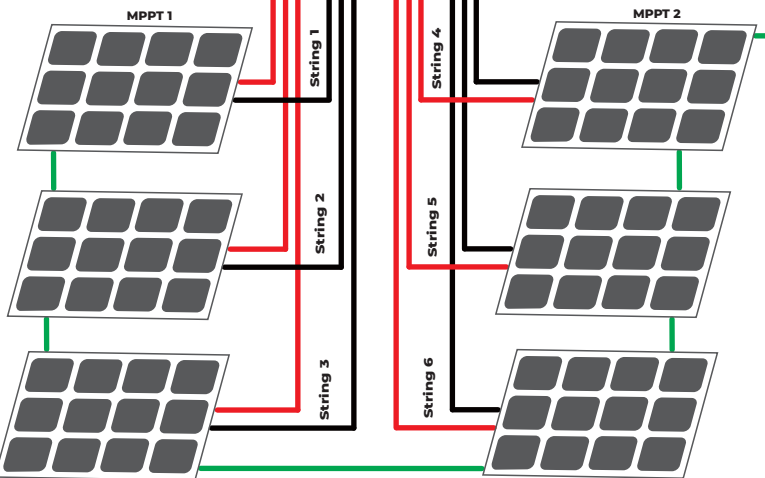

■ Eletrodo de Aterramento

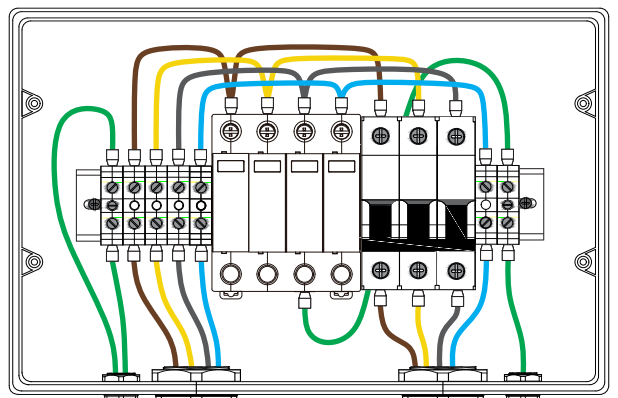
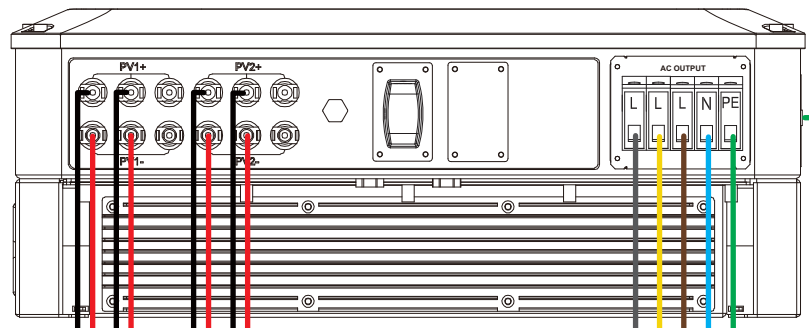
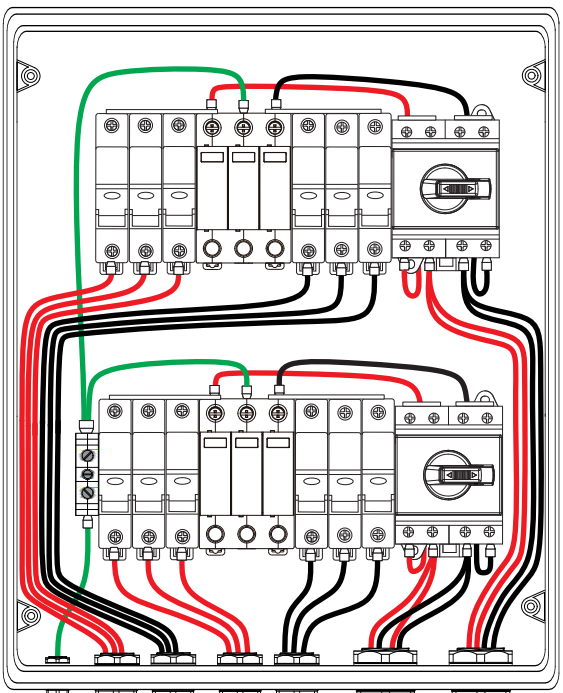